

Technical Information

How to Choose Ferrite Components for EMI Suppression

Introduction

The following pages will focus on Soft Ferrites used in the application of electromagnetic interference (EMI) suppression. Although the end use is an important issue and some applications are mentioned, this technical section is not intended to be a design manual, but rather, an aid to the designer in understanding and choosing the optimum ferrite material and component for their particular application. Ferrite suppressor cores are simple to use, in either initial designs or retrofits, and are comparatively economical in both price and space. Ferrite suppressors have been successfully employed for attenuating EMI in computers and related products, switching power supplies, electronic automotive ignition systems, and garage doors openers, to name just a few.

Use of Ferrite Suppressor Cores

The United States was one of the first countries to recognize the potential problems caused by electromagnetic pollution. As a result the FCC was charged with the responsibility of promulgating rules and regulations to control and enforce limits on high frequency interference.

Figure 1 shows the current radiation limits as defined by FCC Rules Part 15, for class A (industrial) and class B (mass-market) equipment.

Contrary to the times when these regulations were first enforced and designing for EMI protection was often an afterthought rather than a forethought, a major portion of today's circuitry is incorporating EMI safeguards in its initial design. Many approaches can be used to comply with design or specification limits for EMI. Attention to basic circuit design, component layout, shielded enclosures and other use of shielding materials may be considered. For reducing or eliminating conducted EMI on printed circuit boards in wiring and cables, ferrite components have been used very successfully for decades. The ferrite core introduces into the circuit a frequency variable impedance, see Figure 2. The core will not affect the lower frequency operating signals but does block the conduction of the EMI noise frequencies. The Figures 3 and 4 are photographs of a representative sampling of the Fair-Rite Products Corp. product line of suppressor cores.

Conducted Limits*		
Frequency	Class A	Class B
450 kHz - 1.6 MHz	60 dBuV	50 dBuV
1.6 MHz - 30 MHz	70 dBuV	60 dBuV

*Measured using a 50-ohm LISN

Radiated Limits**		
Frequency	Class A	Class B
30 MHz - 88 MHz	50 dBuV/m	40 dBuV/m
88 MHz - 216 MHz	53 dBuV/m	43 dBuV/m
216 MHz - 960 MHz	56 dBuV/m	46 dBuV/m
above 960 MHz	64 dBuV/m	54 dBuV/m

**Measured at a 3-meter distance

Figure 1 FCC Radiation Limits for class A & B equipment.

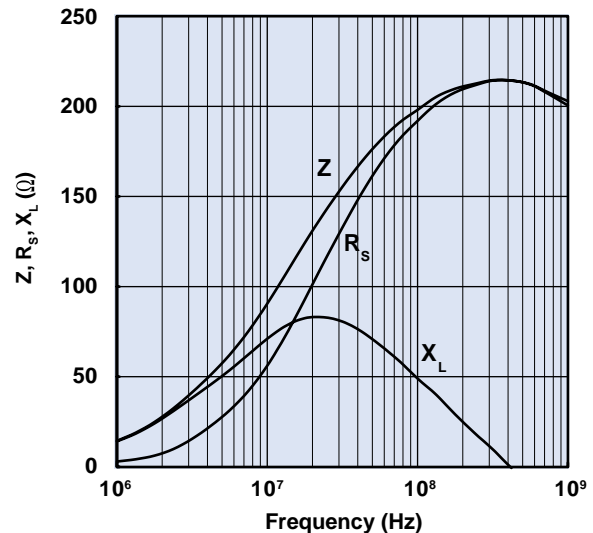

Figure 2 Impedance, reactance, and resistance vs. frequency for a ferrite core in 43 material.

Technical Information

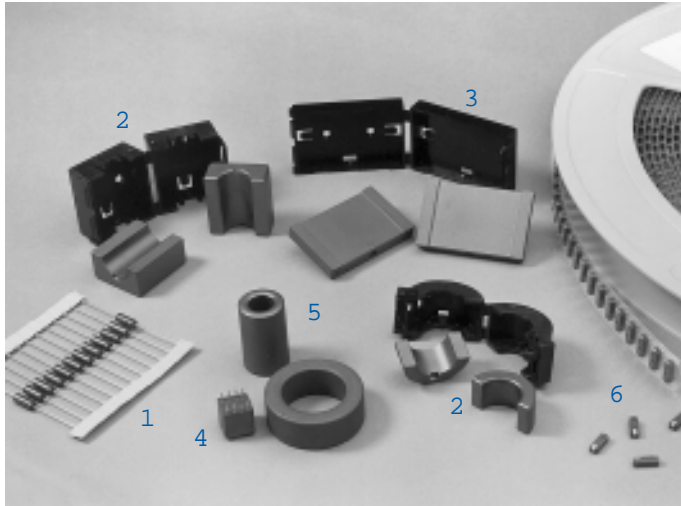

Figure 3, 4 Variety of EMI Suppression Cores including: (1) Beads on Leads, (2) Split Round Cable Suppression Cores and Cases, (3) Split Flat Cable Suppression Cores and Cases, (4) Printed Circuit (PC) Beads, (5) Toroidal Type Shield Beads, (6) Surface-Mount (SM) Beads, (7) on Reel, (8) Wound Beads, (9) Connector Suppression Discs and Plates and (10) One of nine Engineering Kits containing a Large Variety of Samples of EMI Suppressor Cores.

The Magnetics

The permeability of a ferrite material is a complex parameter consisting of a real and an imaginary part. The real component represents the reactive portion and the imaginary component represents the losses. These may be expressed as series components (μ_s', μ_s'') or parallel components (μ_p', μ_p'').

Figure 5 is the vector representation of the series equivalent circuit of a ferrite suppression core; the loss free inductor (L_s) is in series with the equivalent loss resistor (R_s). The following equations relate the series impedance and the complex permeability:

$$Z = j\omega L_s + R_s = j\omega L_o (\mu_s' - j\mu_s'') \text{ ohm}$$

so that

$$\omega L_s = \omega L_o \mu_s' \text{ ohm}$$

$$R_s = \omega L_o \mu_s'' \text{ ohm}$$

where: $L_o = \frac{4\pi N^2 10^{-9}}{C_1}$ (H) is the air core inductance.

The impedance of a ferrite suppressor core is a combination of the intrinsic material characteristics μ_s' and μ_s'' , the square of the turns and of the ferrite core. The complex permeability components μ_s' and μ_s'' vary as a function of frequency. The core geometry and the number of turns are frequency independent contributors to the overall impedance.

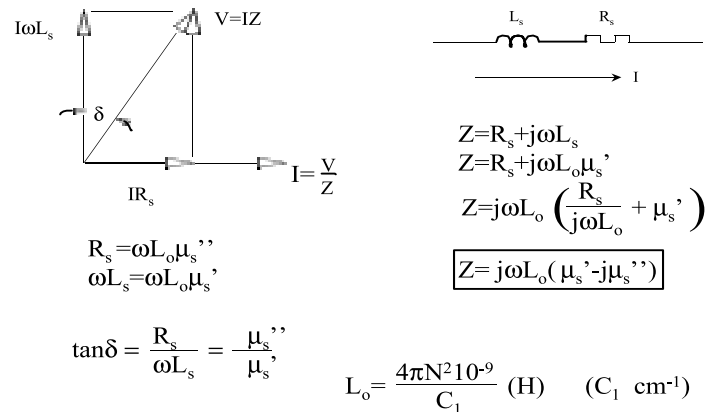

Figure 5

Material Selection

Conducted EMI can occur over a wide range of frequencies, from as low as 1 MHz to several GHz. To provide protection over such a wide frequency range a number of ferrite materials will have to be made available.

Fair-Rite offers a complete line of suppression ferrites that cover a gamut of frequencies. Starting at 1 MHz MnZn ferrites 73 and 31 are used. Beginning around 20 MHz up to 200/300 MHz the NiZn materials 43 and 44 are recommended. For the highest frequencies the NiZn 61 material is the choice.

Technical Information

Figures 6 through 10 show for these five suppression materials the complex permeabilities μ'_s and μ''_s as a function of frequency. For all these materials at low frequencies μ'_s is highest but as the frequency increases μ''_s becomes the dominant material parameter whence the biggest contributor to the overall impedance. At the low frequencies where μ'_s is highest the suppression core is mostly inductive and rejects EMI signals. At the higher frequencies where μ''_s becomes the more significant parameter the impedance will become more and more resistive and absorbs the conducted EMI.

Table 1 lists Fair-Rite's suppression materials, suggested operating frequency ranges and the test frequencies for the five suppression materials. The recommended materials will provide the highest combination of the primary material characteristics μ'_s and μ''_s over that frequency range.

Table 1

Material	Frequency Range	Test Frequencies	Comments
73	1 - 25 MHz	10 - 25 MHz	Small parts only
31	1 - 300 MHz	10 - 25 - 100 MHz	Large parts only
43	20 - 300 MHz	25 - 100 MHz	Wide range of parts
44	20 - 300 MHz	25 - 100 MHz	High resistivity
61	200+ MHz	100 - 250 MHz	For VHF designs

Making the material selection is the first step in eliminating conducted EMI problems. To make this material selection it is imperative that the frequency or frequencies of the unwanted noise are known. This needs not be an exact figure; an approximation will be sufficient. From the EMI frequency the material can be selected. It should be made clear that several environmental conditions will have to be addressed before this selection becomes final.

Environmental Conditions

As shown in Figures 6 through 10, the μ'_s and μ''_s will vary as a function of frequency. However, several environmental conditions will also affect these primary material parameters. The most significant ones are temperature and dc bias.

Changes in the combination of μ'_s and μ''_s due to temperature is strictly a material characteristic which is not affected by the core geometry. The graphs in Figures 11 through 15 show the percentage change in impedance as a function of temperature when compared to room temperature. These typical changes in impedance will be applicable for all components made from these materials. Designers can use these graphs to evaluate performance of specific components versus temperature.

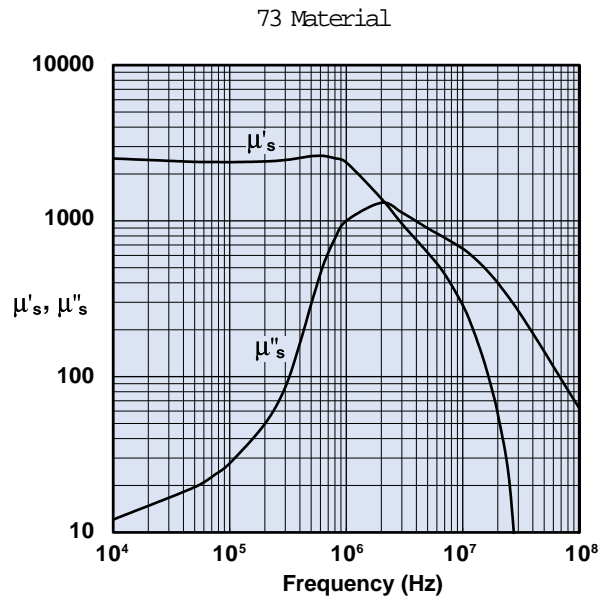

Figure 6 Complex Permeability vs. Frequency Measured on a 2673000301 bead using the HP 4284A and the HP 4291A.

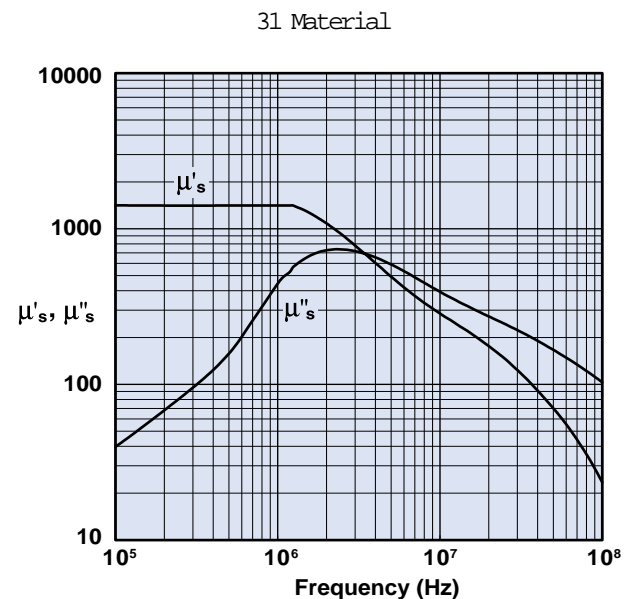

Figure 7 Complex Permeability vs. Frequency Measured on a 17/10/6mm toroid using the HP 4284A and the HP 4291A.

Technical Information

43 Material

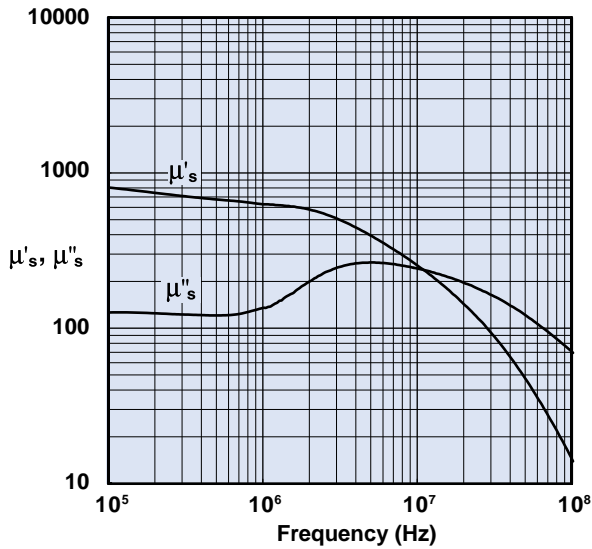

Figure 8 Complex Permeability vs. Frequency Measured on a 17/10/6mm toroid using the HP 4284A and the HP 4291A.

61 Material

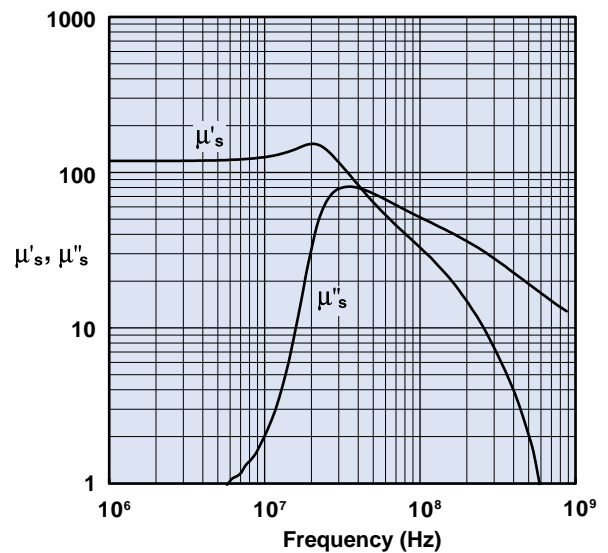

Figure 10 Complex Permeability vs. Frequency Measured on a 17/10/6mm toroid using the HP 4284A and the HP 4291A.

44 Material

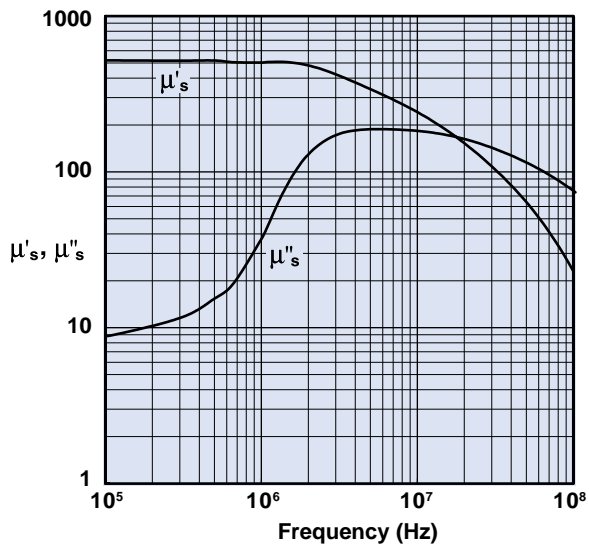

Figure 9 Complex Permeability vs. Frequency Measured on a 17/10/6mm toroid using the HP 4284A and the HP 4291A.

The dc bias is more complex. The dc bias will affect both the μ'_s and μ''_s , but this is also influenced by the core geometry, specifically the magnetic path length. Therefore Fair-Rite provides dc bias information based on a dc H field in oersted for many of its suppression components. For all EMI suppression beads and round cable suppression cores listed in the catalog a calculated H value ($H=1.256/I_m$) that is based on a single turn and one Amp direct current is shown. This calculated value of H should be modified if more turns are used or if the current is not 1 A. A 2 Amp current will of course double the value listed for the part. Once the true dc H field is calculated, graphs in Figures 16 through 20 will provide the change in impedance information for the appropriate material, frequency and true H value.

Dc bias curves are included in this catalog for wound and assembled parts as well as for those components for which the magnetic path length cannot be easily calculated. For instance, refer to the product sections for beads on leads, pages 29-40 and chip beads, pages 50-73. For each individual component an impedance vs. frequency curve with the dc bias as a parameter is included. Again, this will provide the designer with a quick evaluation on how the dc affects the performance of these components.

Technical Information

73 Material

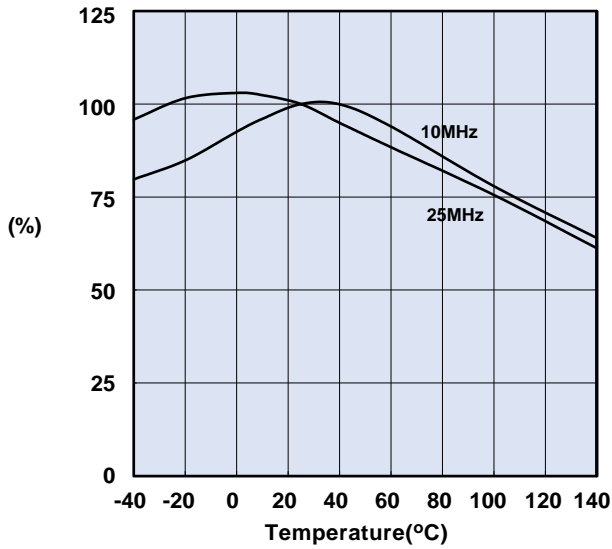

Figure 11 Percent of Original Impedance vs. Temperature Measured on a 2673000301 using the HP4291A.

31 Material

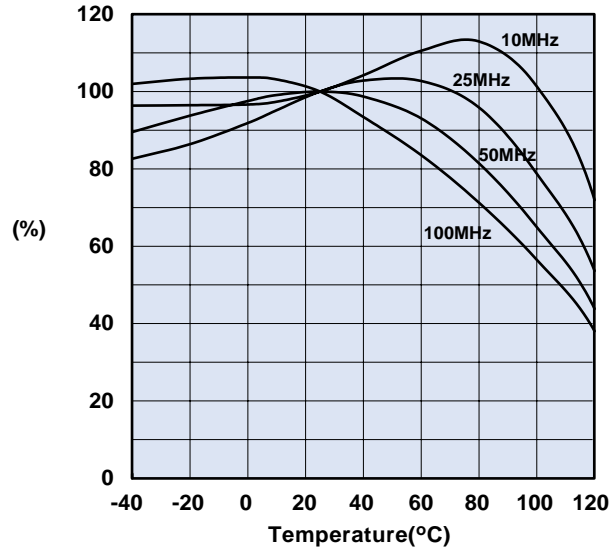

Figure 12 Percent of Original Impedance vs. Temperature Measured on a 2631000301 using the HP4291A.

43 Material

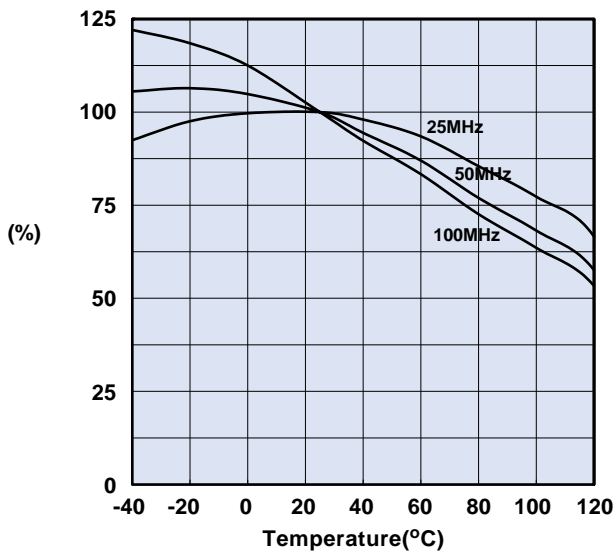

Figure 13 Percent of Original Impedance vs. Temperature Measured on a 2643000301 using the HP4291A.

44 Material

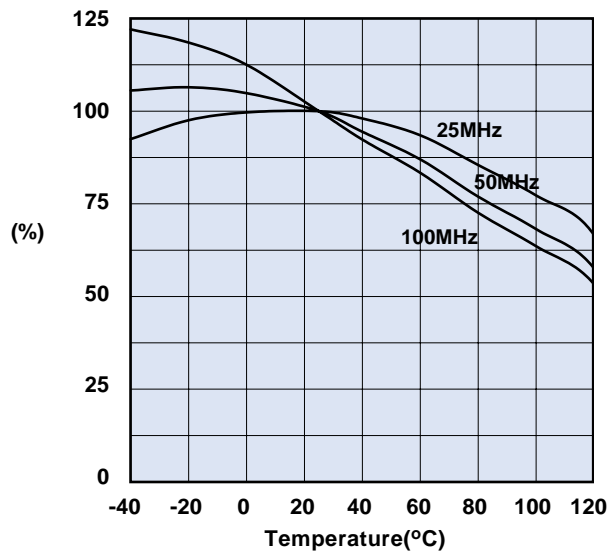

Figure 14 Percent of Original Impedance vs. Temperature Measured on a 2644000301 using the HP4291A.

Technical Information

61 Material

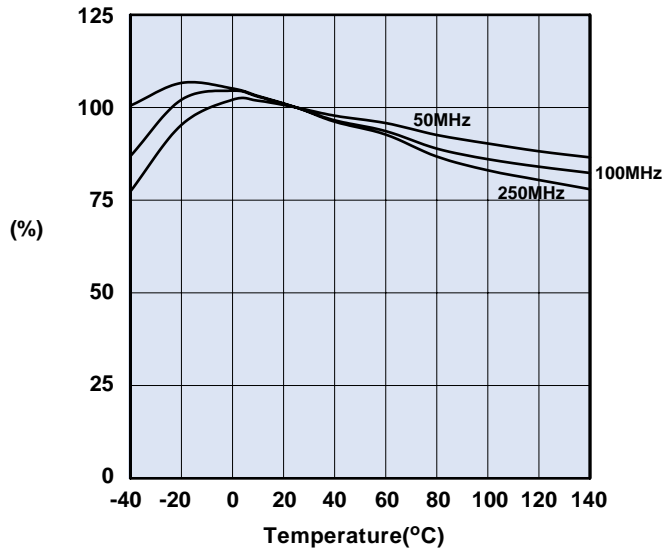

Figure 15 Percent of Original Impedance vs. Temperature Measured on a 2661000301 using the HP4291A.

73 Material

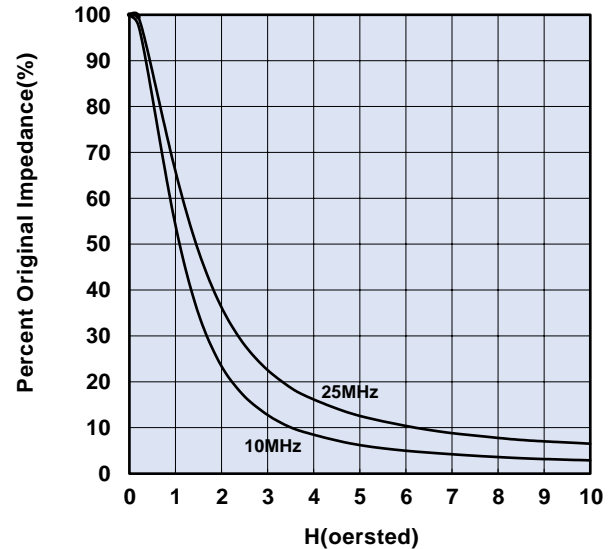

Figure 16 Percent of Original Impedance vs. Magnetic Field Strength. Measured on a 2673000301 using the HP4291A.

Secondary Material Parameters

Although μ'_s and μ''_s are the most critical material characteristics for suppression applications, resistivity and Curie temperature are ferrite material parameters that should be considered as well.

The Curie temperature is the transition temperature above which the ferrite loses its magnetic properties. At this temperature the component is no longer performing its intended function. Once the material cools down below this temperature it will again perform as before. For all Fair-Rite materials a minimum Curie temperature is specified.

As mentioned previously, Fair-Rite manufactures two classes of ferrite materials, MnZn and NiZn ferrites. The manganese zinc materials have low resistivities whereas the nickel zinc materials have high resistivities. For applications that use non-insulated wires or for use as connector suppression plates, a ferrite material with the highest resistivity is recommended. Fair-Rite's 44 material is an improved 43 material by providing both increased resistivity and Curie temperature. Components in the 44 NiZn material are catalog standard parts for connector plates and wound parts such as PC beads and wound beads.

31 Material

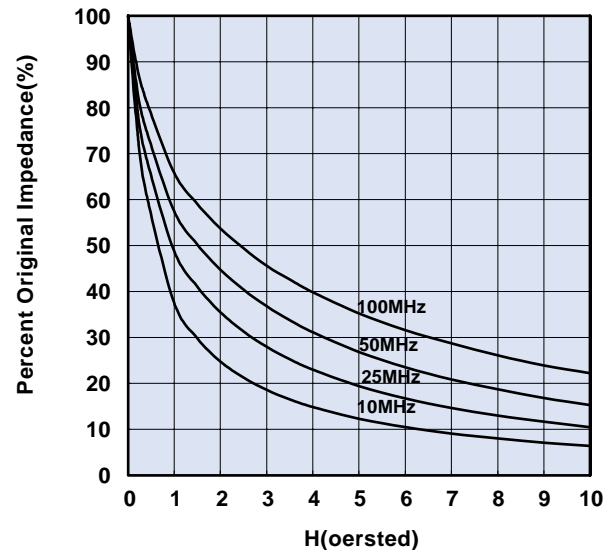

Figure 17 Percent of Original Impedance vs. Magnetic Field Strength. Measured on a 2631000301 using the HP4291A.

Technical Information

43 Material

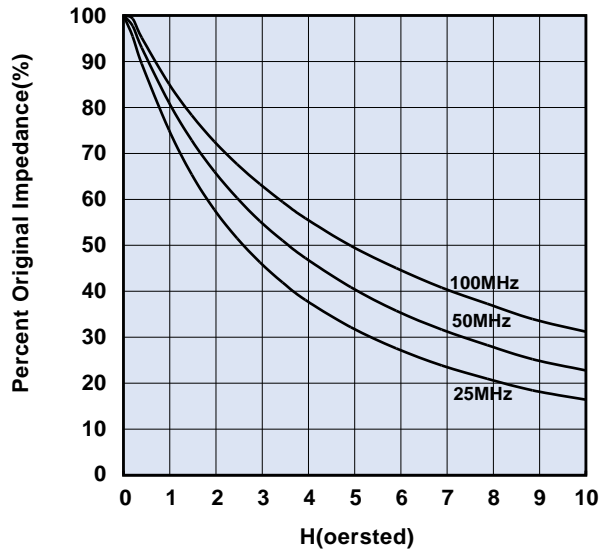

Figure 18 Percent of Original Impedance vs. Magnetic Field Strength. Measured on a 2643000301 using the HP4291A.

44 Material

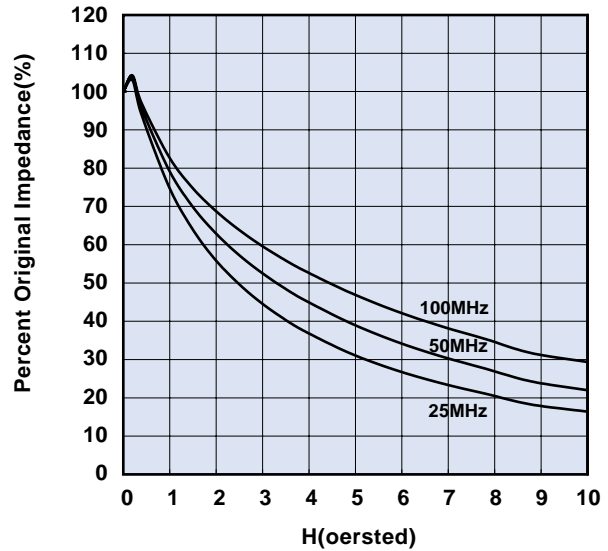

Figure 19 Percent of Original Impedance vs. Magnetic Field Strength. Measured on a 2644000301 using the HP4291A.

61 Material

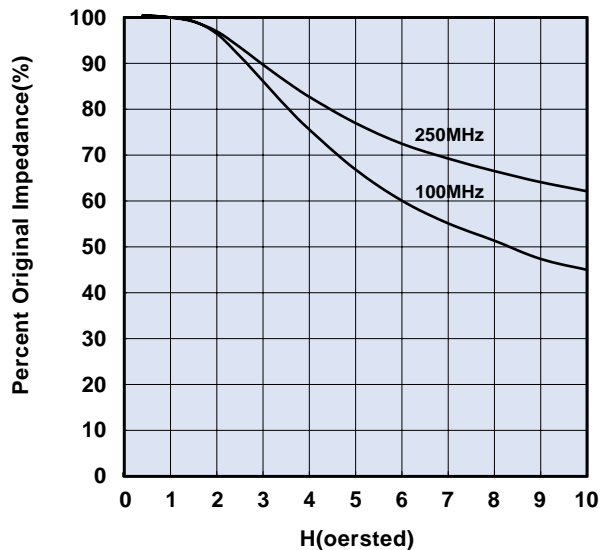

Figure 20 Percent of Original Impedance vs. Magnetic Field Strength. Measured on a 2661000301 using the HP4291A.

Common-Mode Design

If the dc currents are so high that the resulting impedances are not sufficient to suppress the conducted noise, the common-mode approach might solve the problem. As shown in Figure 21, in a common-mode design both current-carrying conductors will pass through the same hole in the core. The dc fields will cancel and the common-mode noise that is picked-up on both lines will be attenuated. It should be pointed out that an EMI signal that is on the line to the load and then returns from the load will not "see" the core and will not be attenuated.

In applications with a large direct current in a single conductor, the solution might be the use of an open magnetic circuit core such as a wound ferrite rod. In automotive designs where the ground is used as the return path, this often is the only option.

When high frequency operating signals, typically above 1 MHz, are susceptible to EMI, the common-mode approach might be used to solve that problem. In this instance common-mode is not used for the current compensation, but rather for the compensation of the high frequency signals. These signal pairs will be not be suppressed, yet any common-mode EMI will be attenuated. The use of round or flat cable cores is a good example of this application of this type of common-mode suppression.

Technical Information

Common-Mode Design

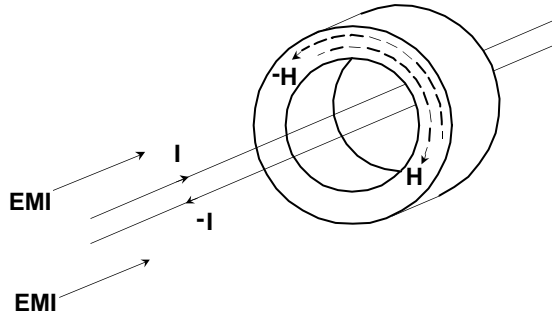

Figure 21

Core Selection

Once the proper ferrite material for a specific suppression application has been decided the required ferrite core is the next step in solving the EMI problem. The core contribution to the impedance is expressed in the formula

$$L_o = \frac{4\pi N^2 10^{-9}}{C_1} \quad (H)$$

From this formula it is evident that the impedance is proportional to the square of the number of turns and the core geometry shown by the core constant C_1 . The advantage of the proportionality of N^2 is often overlooked and yet can enhance the overall impedance significantly for a rather minor cost. Figure 22 shows the impedance versus frequency curves for one of Fair-Rite's 43 material cable cores wound with one, two and three turns. By increasing the number of turns the winding capacitance is increased resulting in a shift in the maximum impedance to lower frequencies. If an improvement of the low frequency impedance performance is needed, this increase in turns can be very beneficial for the 43 material applications.

The core geometry most often used in suppression applications is the toroidal core. When the dimensions are in inches, the L_o for the toroidal core shape is $1.17 N^2 H \log_{10} OD/ID 10^{-8}$ (H). Of the three core dimensions OD, ID and H (height), the H is the most significant. This dimension is proportional to the toroidal L_o and hence of the impedance of the core. Doubling H will double the volume and also the impedance. Doubling the core volume by changing the OD and or the ID will only increase the impedance by approximately 40%.

Overall the process of selecting a bead or cable core that fits the wire or cable is mainly a mechanical evaluation, but the longer the selected core the higher the impedance for a given volume of ferrite material.

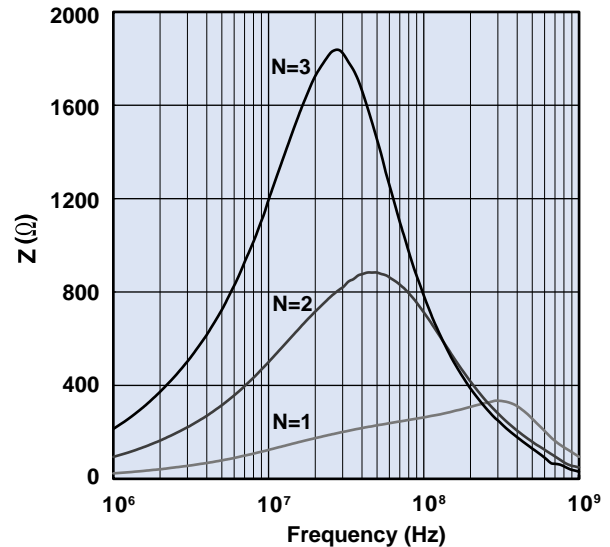

Figure 22 Impedance vs. frequency for a 14/6/28mm cable core in 43 material wound with one, two, and three turns.

Suppression Materials

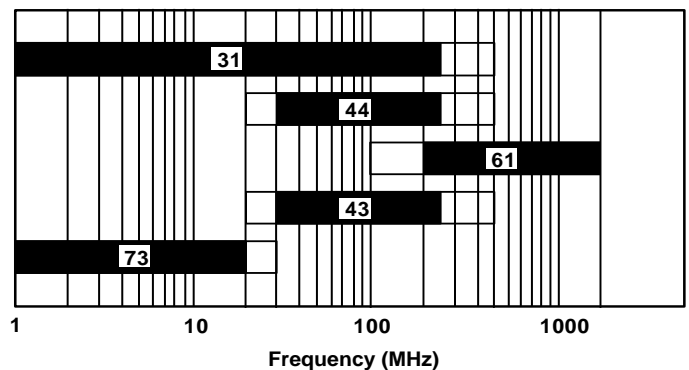

Figure 23 Available Fair-Rite Suppression Materials vs. Frequency

Technical Information

Suppressing Common-Mode Noise

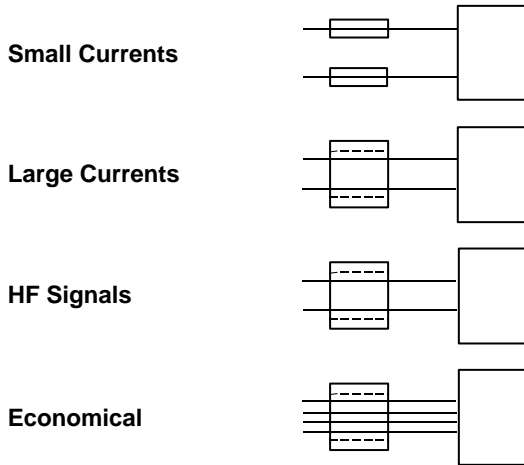

Figure 24

Suppressing Differential-Mode Noise

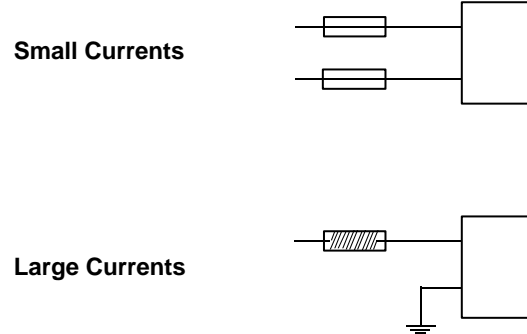

Figure 25

Summary

1. Material Selection

The graph in Figure 23 aids in the initial material selection for suppressing conducted EMI frequencies.

DC bias, core size, operating temperature and resistance requirements might affect this choice.

2. Core Selection

To make a final core selection, the type of EMI, common-mode or differential-mode, will affect the choice of the core configuration.

Figures 24 and 25 provide an overview of the available core shape options for different levels of input currents.

Although the catalog lists hundreds of suppression components, we at Fair-Rite Products Corp. will manufacture parts to fit customer specific applications. Contact one of our representatives or our sales office in Wallkill, NY with your requirements.